



A strong platform for strong partners.

# The Bodybuilder Portal.

Mercedes-Benz



Concerning the information in this brochure. Any colour deviations are due to the printing process. This publication may contain models and services that are not available in certain countries. This brochure is used internationally. However, any information on statutory, legal and fiscal regulations and impacts are valid only for the Federal Republic of Germany at the time this brochure went to press. <https://bb-portal.mercedes-benz.com>

Daimler AG, Stuttgart TE/SFB, VAN/VMA • 1Z000 • 02/0908 Printed in Federal Republic of Germany / Imprimé en République fédérale d'Allemagne

bb-portal.mercedes-benz.com

https://

Welcome!

In order to achieve a crucial advantage in the international marketplace and, together with you as a bodybuilder, to supply our customers with the ideal commercial vehicles, we attach great importance to our close cooperation with you – be it through your product standards, our training courses, events, newsletters, the Europe-wide network of experienced bodybuilder managers or the design of optimal interfaces and processes. It is our conviction that success is born of strong partnership.

In this endeavour, we rely on the exchange of information and ideas, on personal contacts – and on our revised Bodybuilder Portal. Redesigned in accordance with the feedback we have received from you, the Bodybuilder Portal is now more than ever before a comprehensive communication platform that will take you quickly and efficiently to the people and information you require in your day-to-day work.

This brochure will introduce you to a selection of content and applications which we have improved or newly added in line with your wishes, such as:

- 3D data of Mercedes-Benz trucks – for optimised body designs
- New order data system – for online tracking of orders, dates and configurations
- Van Partner – a milestone in the marketing of your body designs
- Even better and easier to use – all information available at a glance
- Optimised search functionality – for directly finding what you need
- Information on vehicle electronics – wiring diagrams, functions, instructions
- Your international Mercedes-Benz contact persons – available round the clock

Visit our Bodybuilder Portal. We are constantly adding to and developing the content. Should you have any questions or requests, please do not hesitate to contact us, either online or in person. Our contact details can be found in the Portal in the “Contact” link in the footnote. We look forward to your visit.

Bodybuilder Management Trucks & Vans



“Clear designs at the click of a mouse, even in 3D! It doesn’t get any better than that. It means I can finally achieve more for our customers.”

Peter Terensen, vehicle designer



# More information - more value.

Since the Bodybuilder Portal went online in 2004, the number of visitors has grown constantly. We believe this is due in particular to the quality of the content and to the fact that this platform is continuously being improved in line with your wishes.

**A portal that meets many needs.** One million hits per month, over 60,000 visitors per quarter and already 3,500 registered bodybuilders from over 60 countries - this all clearly demonstrates that the Bodybuilder Portal has been a global success, benefiting all users in their day-to-day work. The advantages are clear to see:

- Markets, customer requirements and commercial-vehicle standards are subject to rapid change - the latest bodybuilder information always keeps you up to date.
- Complex information in the shortest possible time - the central Internet platform makes collaboration simple, quick and effective.
- Targeted development of markets with the support of a strong partner - as a Qualified Partner of Mercedes-Benz, you significantly improve your sales chances.

**On the up.** In recent years, there has been more than an eightfold increase in the number of global visitors to the Bodybuilder Portal. At present, we are registering around 20,000 visits to the Portal every month. You, too, stand to benefit from the wealth of knowledge about our commercial vehicles as well as from the attractive marketing opportunities that are available to you from the Bodybuilder Portal.

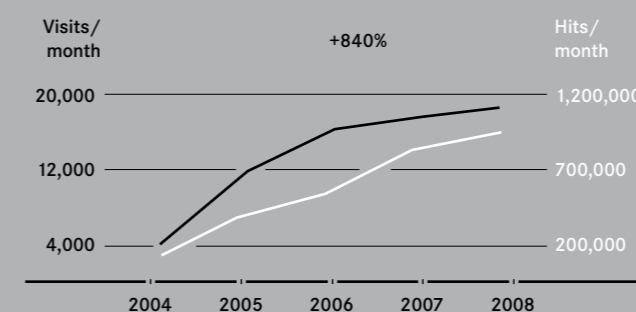

Growth in visits/hits per month

**Support at the click of a mouse.** From order acquisition through design to order processing, the Bodybuilder Portal provides you with a comprehensive selection of technical information and commercial features that you can put to specific use. Round the clock and around the world. Online and in person.

- You have full access to several million information items, data records and drawings of over 25,000 Mercedes-Benz trucks and vans as well as to 3D and 2D data. This allows you quickly to design your body so that it is a perfect fit for our chassis. Or you can display the complete vehicle precisely in the form required by the customer, including paintwork.
- Numerous practical bodybuilder applications, such as product information sheets, the order data system and online approval for certificates of non-objection, will support and speed up the initiation and processing of your orders.
- Introduce yourself to your customers or salespersons with your company profile and products, which you can place here directly. As a Qualified Partner, you also benefit from numerous marketing opportunities provided by the Portal.
- Our Bodybuilder Information bulletins (e-mail newsletters) will regularly inform you, if you so wish, about innovations to Mercedes-Benz commercial vehicles and any updates to the Bodybuilder Portal. And, if you ever need help on how to use the Portal, you can always contact our Portal Hotline in person.
- With the growing international focus of the Portal, you will in future have access to many other language versions and country-specific information.

# New features and functions to get you there faster.

Which vehicle do you require? The new Bodybuilder Portal offers you a wealth of information and possibilities. Sophisticated search functions allow you to find what you need in just a few mouse clicks. Here you can access data

## Bodybuilder Portal – what’s new



**The complete picture – 3D design data.** Make your designs both clear and simple. The Bodybuilder Portal provides you with access to all those chassis components that are of relevance with regard to installation space.



**Everything within easy reach – the order data system.** Whether it’s completion dates, configurations or drawings of Mercedes-Benz truck chassis, the new order data system always keeps you up to date and provides you with a comprehensive overview of your orders.

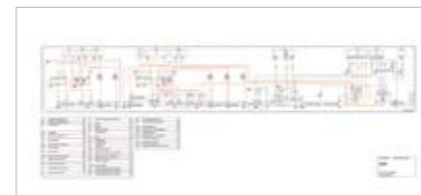

**Everything you need – data on electrics and electronics.** Versatile and flexible: the parameterisable special module (PSM). Information on the PSM and wiring diagrams of Mercedes-Benz commercial vehicles are made available to you through the Bodybuilder Portal in the shortest possible time.

## Bodybuilder Portal – the content

### Current Topics

- News
- Newsletter archive (Bodybuilder Information)
- Dates of trade fairs/events etc.
- Latest Bodybuilder News magazine (vans)
- Special on BlueTec®/AdBlue

- Login/registration
- Password reset
- Latest news

- Sitemap
- Search
- Contact

### Technology (MBAS-Web)

- Body Mounting Directives
- 2D chassis drawings
- 3D components
- 3D chassis displays
- Cab drawings
- Technical data sheets
- Equipment, code descriptions, weights
- Electrics/electronics, PSM
- Wiring diagrams
- PTOs (power take-offs)
- Engine diagrams
- Performance diagrams
- Interface parts
- Owner’s manuals
- Additional information

### Partnership

- Bodybuilder Hotline
- Bodybuilder contact persons at Mercedes-Benz
- Contact person database
- Mail request form
- Training programmes
- Training materials
- Explanatory notes on the Qualified Partner process
- Entry to the Branch Information Center (BIC)
- Entry to CTT (Custom Tailored Trucks) and to MB dealers

on over 25,000 chassis and vehicle variants of Mercedes-Benz trucks and vans. Comprehensive, detailed and clearly arranged.



**Showing yourself to advantage – on the web with Van Partner by Mercedes-Benz.** Present your van body designs to customers and Daimler sales staff using the new Internet website [www.vanpartner.de](http://www.vanpartner.de) from Van Partner by Mercedes-Benz. You can upload your data through the Bodybuilder Portal.



**Finding things easily – the search function.** Take the direct route to what you need. Use our extended and simple search function to find out everything you wish to know. Quickly and easily.



**Regular service – Bodybuilder Information bulletins (e-mail newsletters).** These ensure that you are always kept informed. Simply register through your user profile on the Bodybuilder Portal and we will send you regular updates by e-mail.

### My Portal

- Requests for quotations
- Order data
- User settings
- Company profile
  - Management of company data
  - Company information for the Qualified Partner process
  - Marketing for your products to MB dealers and MB customers
  - Obtaining certificates of endorsement
  - Granting your contact persons/employees access to the Portal

### Tools

- Explanations
  - Basics about MB trucks and vans
  - Model variant logic
  - Tyre profiles
  - Distances between rear axle and fifth wheel kingpin
  - Paint tables
  - Downloads
  - User manuals
  - Necessary plug-ins and programs

### Search

- A – Z glossary of keywords
- Free-text search

# 3D - the future within easy reach.

Ideas for your body designs are now even easier to turn into reality. The 3D data and drawings of Mercedes-Benz chassis on the Bodybuilder Portal provide you with comprehensive support for your 3D body designs.

Now, already when you are submitting your quotations, you have access to all those chassis components that are of relevance with regard to installation space, such as chassis, cab/engine air intake, exhaust, fuel tank, suspension, frame overhang, spare wheel and battery carrier of Mercedes-Benz trucks, allowing you to make your designs true to detail.

Also for selected Mercedes-Benz van models, such as the Sprinter 906, you have access not only to the 2D data, but also to the new 3D packages. Simply order these packages using the order form (in the additional information catalogue). You will then receive the data in STEP, CATIA 4 or CATIA 5 format.

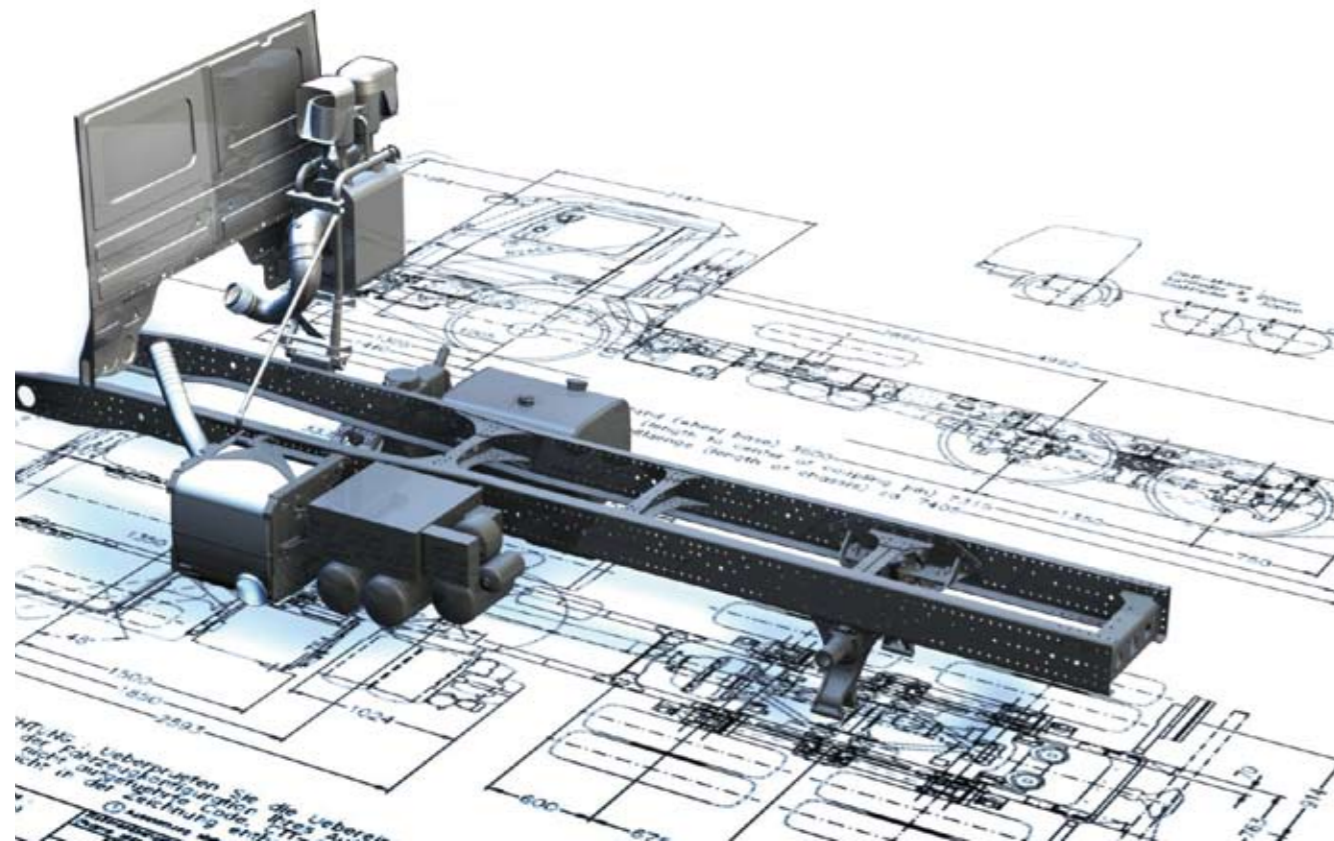

**Designing with 3D data.** The data available from the Portal will allow you to realise perfect 3D designs. First select the vehicle components you require, generate a preview and you can then download the individual components in their installation positions for subsequent further processing within your CAD programs.

The data are available in the STEP format, which provides you with maximum possible compatibility with all current 3D design programs. Of course, all chassis drawings are also still available in 2D as PDF and DXF files.

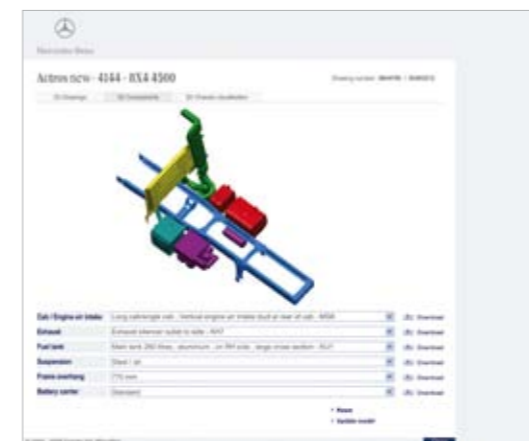

**3D display of chassis.** In addition to the many features for guaranteeing ideal 3D designs, the Bodybuilder Portal provides you with additional and attractive possibilities for displaying Mercedes-Benz truck chassis.

To do this, select the model series of truck you require with the special equipment options. Next, define the colours for the basic cab, entrance area and radiator grille. This is how you generate a 3D turntable in a 360 degree view. Now you can download JPEG image files in high display quality for any desired views and use them, for example, as an attachment to your quotation. The result is a high-quality representation of the complete vehicle corresponding to your configuration and your selected colours.

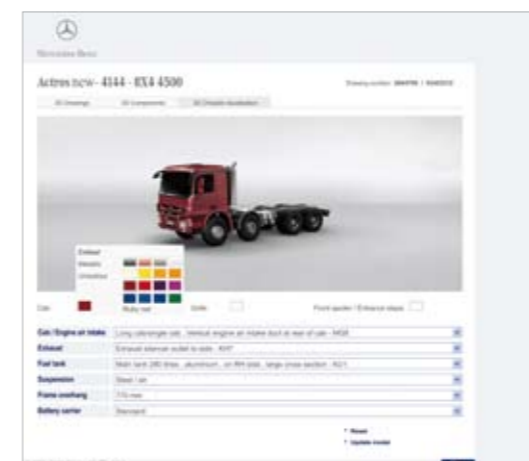

We are constantly further developing our vehicle display concepts. For instance, we plan to provide you in future through the Bodybuilder Portal with data that will enable you to deliver a high-quality representation of your 3D body complete with our chassis.

# Technology for designers and commercial staff.

You can now work with even greater accuracy and efficiency. The Bodybuilder Portal provides you not only with a wealth of technical data on all Mercedes-Benz trucks and vans, but also with many other sophisticated and practical tools and features which you require for your day-to-day commercial work with regard to all aspects of order acquisition and processing.



**Standard or special equipment code.** The Bodybuilder Portal contains the entire range of equipment options for Mercedes-Benz commercial vehicles. The new equipment catalogue informs you about all possible standard or special equipment options with code, short description, weights, technical details and extensive images. You can also find information here on code dependencies and configurations.



**Online and live – operating instructions.** The Bodybuilder Portal now contains all the operating instructions for Mercedes-Benz trucks and vans. Available online in German and English. And very simple to use thanks to the navigation bar. You can search either by subject, such as safety, operation or self-help, or you can use the alphabetical subject index to find the information you require. Then, just click the mouse to view instructions, tips and tricks in the centre of the screen on how to operate the vehicle.

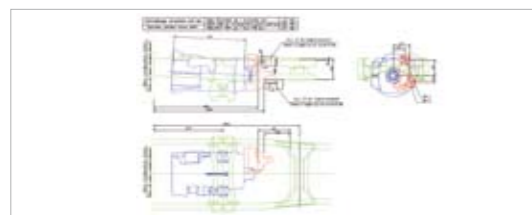

**By vehicle flyer or catalogue – PTOs.** You can find the perfect PTO for your Mercedes-Benz truck either by means of the vehicle flyer of your desired vehicle or using the extensive and clearly arranged PTO catalogue. Various filter functions in the form of pull-down menus will quickly take you to the information you require. The PTO drawings are available in DXF or PDF format.

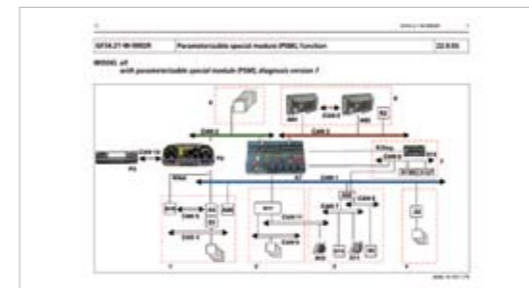

**The ideal connection – PSM.** The “PSM” parameterisable special module is linked via CAN-bus to the two body and trailer CAN communication interfaces, thereby allowing a direct exchange of information between the vehicle electronics and your bodies and implements as well as trailers or semitrailers. The controls are precisely parameterised to the operating data of the series production system. This means that there is a clear definition of the interfaces between the vehicle electronics and the retrofitted system.

#### Everyone benefits from PSM:

- PSM offers a flexible interface integrating additional control mechanisms without the need to intervene in the car vehicle’s electrics.
- Extension of trailer/semitrailer functions by means of a second interface.
- More functions increase the driver’s working efficiency and comfort.

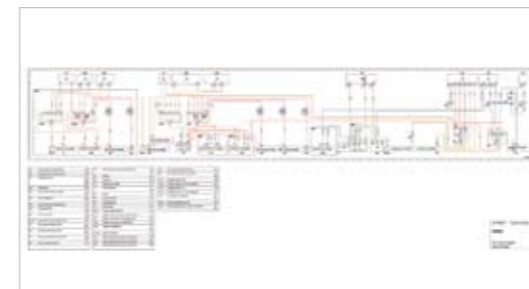

**Technical catalogue – wiring diagrams.** Wiring diagrams show you how the control units in Mercedes-Benz commercial vehicles are interconnected. The Bodybuilder Portal provides you with access to over 400 wiring diagrams for our model series of trucks and vans. All wiring diagrams are arranged by function group and can be found quickly and efficiently using filter functions. Full size or optimised for printing. You can view, download or print all wiring diagrams free of charge as a PDF document. Either in full size or in a version optimised for printing with crop marks. These allow you to print the wiring diagrams over two or more pages and then to assemble them to form one large diagram.

# Process optimisation and performance.

The new order data system in the Bodybuilder Portal enables you to achieve greater efficiency and effectiveness in your operational processes. The improved features allow you to speed up and optimise your business processes in an extremely simple manner. This not only saves valuable time, but also reduces costs.

The extended search function, combined with a new more powerful server and clearer catalogue presentation, reduces the loading times, thus taking you even faster to where you want to go.

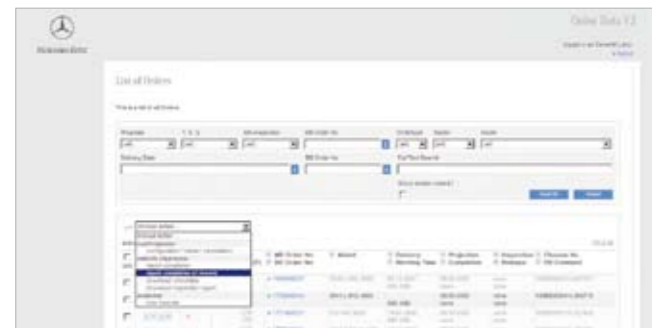

**Excellent for business – the new order data system.** The problem: how to keep a constant eye on and coordinate all your order-related processes. The solution: the improved order data system in the Bodybuilder Portal.

This will make your work in future even more convenient and efficient – and you will optimise those expensive processing times and downtimes within your company.

Immediately after you have logged in, the summary of orders shows you all your assigned orders automatically (in the case of single-invoice transactions) or with manual input (in the case of dual-invoice transactions). One of the new features is the filters, which allow you easily to execute a detailed search for the required data or to create and edit new data records. And what are the advantages for you? You can optimally check your chassis configuration and you can control your order and production processes even more efficiently.

## All information quickly to hand:

- Completion dates
- Configurations, equipment
- Order-related drawings
- References to changes of dates and configurations
- Requests for quotations
- Customer addresses and production numbers
- Vehicle inspection

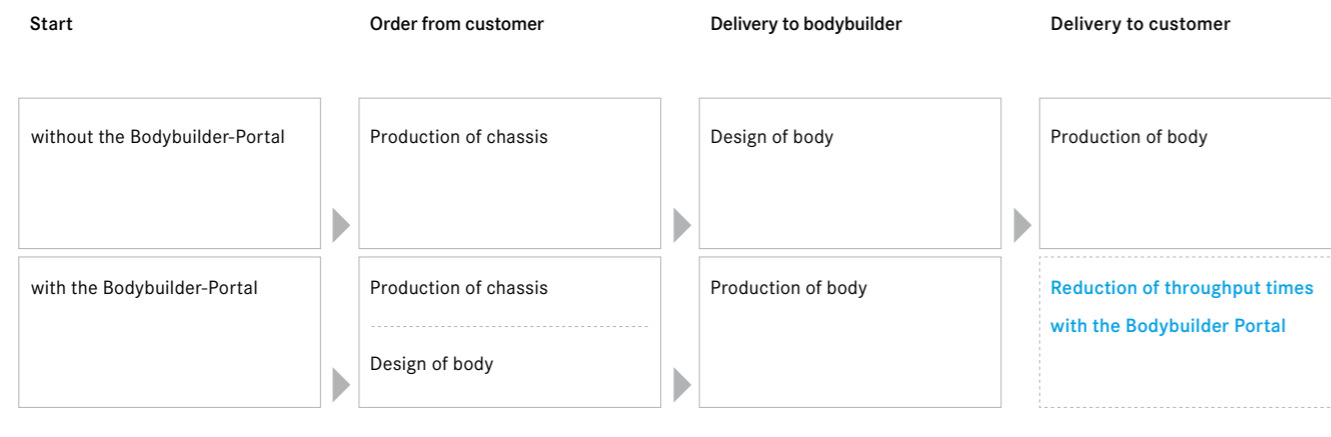

Optimisation of processing times with the new order data system

**Optimised time management for delivery of your chassis.** Reliable time scheduling is one of the added benefits of the new order data system. Now you can synchronise your processes with ours, make a timely start on the design and production of your body – and optimise your processing times, reduce downtimes and optimise throughput times.



**Standardised system for requesting quotations from Daimler AG as general contractors.** In those cases where we acquire van bodies from you for resale to our customers (i.e. in the case of so-called single-invoice transactions), the requests for quotations are forwarded to you directly online by Mercedes-Benz van salespersons and dealers. Your requests for quotations are processed by the Mercedes-Benz salespersons. Since the process for requesting quotations is standardised, this rules out any possibility of misunderstandings and we are able to process the quotation as quickly as possible. Furthermore, automated inspection processes for special-purpose bodies ensure even greater process reliability. All requests for quotations are documented in a standardised manner.

**Convenient – the new search and filter functions.** Designed as a navigation aid, the new search functions save you time and effort. Using an alphabetical glossary with search terms from A to Z or, alternatively, by means of a free-text search, you can find the required documents or applications within the Bodybuilder Portal – quickly and without detours. Direct links take you to the required content in just a few mouse clicks. We are constantly adding to the glossary of keywords and to the search terms for the free-text search.



**User-friendly and fast – the new technical catalogues.** With new servers and optimised programming of the technical catalogues, it has been possible to speed up the loading times by up to 80%. Handling has also been decisively improved, because all the tables are now permanently integrated into the page structure and are therefore available for immediate viewing. This saves time and money.

**Simple password resetting.** Should you ever forget your password, you can reset it quickly and safely in the new Bodybuilder Portal in just three steps. Simply enter your e-mail address or user name to access a special link to our security server, where you can create your new password.



“The Bodybuilder Portal is a real benefit. The perfect tool for order acquisition and processing. 50% faster with a 100% success rate.”

Wolfgang Weinberg, managing director

# Van Partner by Mercedes-Benz. Business on the move.

The innovative Van Partner programme with its new Internet website at [www.vanpartner.de](http://www.vanpartner.de) (known as Industry Directory in the previous version) provides you as a Qualified Partner of Daimler AG with profitable dual-invoice transaction sales opportunities (the end customer purchases the basic vehicle from Daimler AG and then orders the bodybuilder to build a body for the vehicle or to convert the vehicle).

**The Van Partner programme.** Van Partner by Mercedes-Benz intensifies the cooperation between you as bodybuilder and Daimler AG as manufacturer of the basic vehicle. Your exclusive status as a Van Partner is publicised to the Mercedes-Benz sales staff and to our joint customers.

**How you benefit – highly attractive sales opportunities.** We additionally offer you as a Qualified Partner the opportunity to play a greater role in order processing within the framework of dual-invoice transactions and also to take part in specific publicity measures.

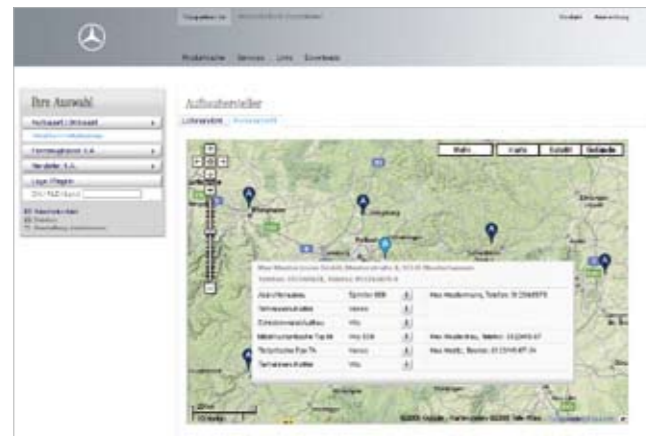

**Your presentation platform on the web.** Publicise your company and products on the Internet in collaboration with Daimler AG. With your product and profile, you will give a tremendous boost to your company's image, recognition level and sales potential – both nationally and internationally.

You can avail yourself of the diverse possibilities for promoting your sales by presenting your products with an unlimited number of illustrations, by publishing your contact persons and company information for your customers or by informing the Mercedes-Benz sales staff in detail about your products and the advantages of the services you offer. This means that Mercedes-Benz sales staff have an excellent supply of presentation materials for use in sales interviews. As a Van Partner, you are able in all cases to guarantee your customer a high-quality product that conforms to the Body Mounting Directives.

**Minimum effort – maximum effect.** Your Van Partner or Van Solution activities are founded on your status as a Qualified Partner as well as on the Bodybuilder Portal, where you can enter and manage your company profile.

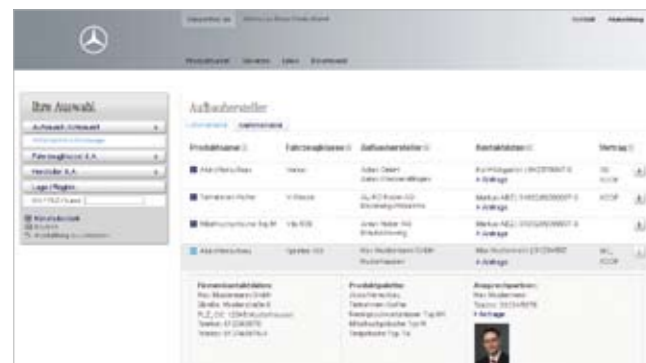

# Excellent sales opportunities for Qualified Partners for trucks and vans.

Mercedes-Benz offers you a host of tailor-made possibilities for optimising your marketing strategy. As a Qualified Partner, you meet one of the basic requirements for using the numerous, country-specific marketing offers for your personal sales activities.

**Branch Information Center (BIC).** As a Qualified Partner, you can under certain circumstances present your truck and van bodies to our joint end customers. For this purpose, the Mercedes-Benz plant in Wörth has around 170 vehicles, complete with bodies, from the Atego, Axor, Actros, Canter, Unimog, Sprinter and Vito model series. BIC customer advisers are on hand to provide authoritative, neutral advice on all chassis, bodies and industry-specific vehicle packages. Over 12,000 potential customers from all branches of industry visited the BIC in 2007. Go to [www.mercedes-benz.de/bic](http://www.mercedes-benz.de/bic) to discover which vehicles are available at the BIC.

**Truck Online Configurator (TOC).** Give your sales a boost. The TOC allows you to directly address Mercedes-Benz end customers with your industry-specific truck body solutions. The TOC contains illustrations of around 80 percent of all buildable vehicles, which means that this platform for Qualified Partners is already today the most extensive offering of commercial vehicles on the Internet.

**Vehicles at trade fairs.** Improve the image of your bodies by showing them in conjunction with Mercedes-Benz commercial vehicles. Only your Qualified Partner status allows you to present your customised bodies in collaboration with Daimler AG at renowned national and international trade fairs.



# Qualified Partner: Partnership of excellence.

Top-class quality and reliability are the guiding principles that underlie our every thought and action. Daimler AG and you, as a Qualified Partner, stand side by side every day with our high-quality chassis and superior body designs to guarantee that these goals are optimally achieved in the interests of our customers.



**Basis for outstanding products.** You benefit in every case from our rigorous quality standards and numerous exclusive training and information offers. This will ensure that you, as a bodybuilder, always stay up to date and are ahead of the field when it comes to commercial vehicle expertise. At the Bodybuilder Portal, you will find all the information you need on training offers and programmes.

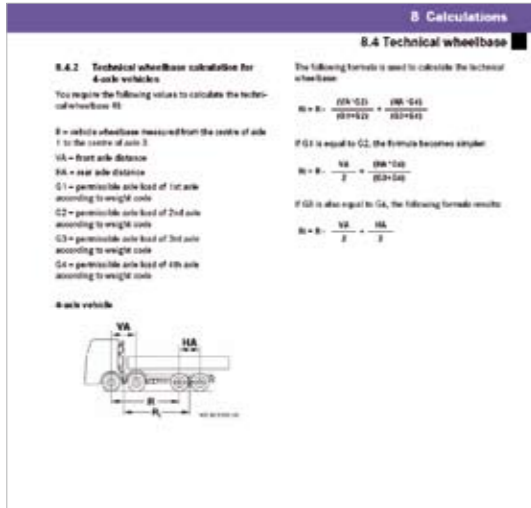

**Body Mounting Directives online.** Strict compliance with the Body Mounting Directives is the basis for all body designs and also one of the most important quality criteria for you as a Qualified Partner. The latest versions of the Body Mounting Directives are now available to you in up to 16 languages from the Bodybuilder Portal. You can view them quickly and without registering. Or, if need be, you can download them as a PDF file.

**Certificates of endorsement online.** If developing industry-specific special solutions that exceed the scope of the Body Mounting Directive, you will require a certificate of endorsement. You can apply for such a certificate either directly to your contact persons in our development department – or online via your company profile in the Bodybuilder Portal.



**Joint development of markets.** We at Mercedes-Benz will provide you with exclusive opportunities and platforms for profitable cooperation. One of the basic requirements for participation is your status as a Qualified Partner. For example, you can show your truck body designs at the Branch Information Center (BIC), publicise your products directly to end customers through the Truck Online Configurator (TOC) or present your van bodies to all salespersons at [www.vanpartner.de](http://www.vanpartner.de).

**Teaming up in pursuit of optimum quality.** In close partnership with you as a qualified bodybuilder, we aim to ensure the high quality of the complete vehicles. So if you wish to become a Qualified Partner, we ask you to supply some additional information about yourself in your company profile – available under “My Portal”. Your data will, of course, be treated in strict confidence.

As a Qualified Partner of Mercedes-Benz, you provide the guarantee of good quality from start to finish.

Quality Management/Development	Sales and Marketing	Service
<ul style="list-style-type: none"> <li>• QM Certificate</li> <li>• Adherence to Mercedes-Benz Body Mounting Directives</li> </ul>	<ul style="list-style-type: none"> <li>• Level of product liability insurance</li> <li>• Sales organization /dealer structure</li> </ul>	<ul style="list-style-type: none"> <li>• Terms of liability for material defects</li> <li>• Number of service stations and service network</li> <li>• Installation and conversion-related documentation</li> <li>• Availability of spare parts</li> </ul>

The Qualified Partner criteria

# The path to greater success: Qualified Partner process.

**Nurturing partnership.** Good partnership consists of giving and taking. The two-way information and communication process within the Bodybuilder Portal is the key to exploiting all our competitive advantages, together as partners. As a Qualified Partner, you stand to benefit from our wide range of attractive marketing opportunities and to present yourself directly to Daimler salespersons alike. In return, you are required to continuously update your company profile, contact persons, product data and company information. This allows us to get to know more about you and your needs.

**A starting point for further activities.** You simply administer your master data online at the Bodybuilder Portal. To become a Qualified Partner you must first supply us with some information about your company. Using your company profile, you can also easily update your list of contact persons or use it, for example, for mailings.

**The route to becoming a Qualified Partner.** In addition to your master data, other key areas include your quality management, development, sales service and some other criteria. Competent Mercedes-Benz experts will assess the information you give, which will, of course, be treated in strict confidence. The criteria for acceptance are internationally identical for every bodybuilder and are definitely achievable. If you meet all the criteria, you will be made a Qualified Partner. In order to guarantee compliance with the required high process standards, this assessment process is repeated at yearly intervals and the Qualified Partner is re-examined.

Where our assessment team identifies an area that may initially represent an obstacle to your inclusion, you will receive support and advice from our experts in order to ensure that you successfully pass the next assessment process.



The Qualified Partner assessment process

“Being a Qualified Partner at the side of a global brand such as Mercedes-Benz gives an enormous boost to our marketing potential – and therefore our market success.”

Brigitte Henning, marketing director



# Just four steps to registering.

# We are always at your Service. Online or in person.

To be able to benefit fully from the complete range of information and opportunities available through the Bodybuilder Portal, you must identify your company when you first visit the Portal as a bodybuilder. This is a very simple process that will take just a few minutes:

1. Type in your user data



2. Fill out your company data



3. Enter your company profile



4. Confirm the disclaimer



## Registration

**Only one registration per company.** The first person to register with the Bodybuilder Portal is initially granted administrator rights for your company profile. Afterwards – without the need for any additional registrations – your administrator can extend access to other members of your company. Administrator rights can also be transferred to someone else, such as your IT specialist.

**Additional company information – even more possibilities.** If you wish to benefit from the numerous exclusive opportunities available to Qualified Partners, then, in the next step, you need to supply some additional information about your company. All required fields are marked in orange in your profile (available under “My Company Profile”). This additional company information can be supplied at a later time independently of the initial registration process.

Quick and direct communication is crucial to the success of our global cooperation and partnership. This is why we offer you a variety of options for contacting us at any time, either through the Portal or in person through your local bodybuilder manager.

**Contact person database.** The contact person database informs you of the appropriate truck or van contact person for your specific question or request with regard to a wide range of different topics, such as quality management, development, vehicle concepts or product inquiries. Please do not hesitate to contact us by phone, e-mail or by post.

**Mail response system.** You can send us your questions at any time using the integrated mail response system. The system uses a form to automatically forward your inquiry to the appropriate contact person at Daimler AG, who will then send you an answer as quickly as possible by e-mail.

**Bodybuilder Hotline.** You can contact our Bodybuilder Hotline with your questions about the Portal from Monday to Friday between 8 am to 4 pm.

Phone: +49 7 11 17-3 33 22

Fax: +49 7 11 17-7 90 73 041

E-mail: [bb-portal@daimler.com](mailto:bb-portal@daimler.com)